





Verbindungsbaustein für 3RV1031 und 3RT102  
Packung = 5 Stück

### Allgemeine technische Daten

Produkt-Markename	SIRIUS
Produkt-Bezeichnung	Verbindungsbaustein
Ausführung des Produkts	für 3RV1031 und 3RT102.
Baugröße des Leistungsschalters	S2
Baugröße des Schützes	S2

### Approbationen/Zertifikate

allgemeine Produktzulassung	Konformitätserklärung	Schiffbau	sonstiges		
	 EG-Konf.	 ABS	 BUREAU VERITAS	 RINA	<a href="#">Umweltbestätigung</a>

### sonstiges

[Bestätigungen](#)

### Weitere Informationen

Information- and Downloadcenter (Kataloge, Broschüren,...)

<http://www.siemens.de/industrial-controls/catalogs>

Industry Mall (Online-Bestellsystem)

<https://mall.industry.siemens.com/mall/de/de/Catalog/product?mlfb=3RA1931-1D>

CAX-Online-Generator

<http://support.automation.siemens.com/WW/CAXorder/default.aspx?lang=de&mlfb=3RA1931-1D>

Service&Support (Handbücher, Betriebsanleitungen, Zertifikate, Kennlinien, FAQs,...)

<https://support.industry.siemens.com/cs/ww/de/ps/3RA1931-1D>

Bilddatenbank (Produktfotos, 2D-Maßzeichnungen, 3D-Modelle, Geräteschaltpläne, EPLAN Makros, ...)

[http://www.automation.siemens.com/bilddb/cax\\_de.aspx?mlfb=3RA1931-1D&lang=de](http://www.automation.siemens.com/bilddb/cax_de.aspx?mlfb=3RA1931-1D&lang=de)

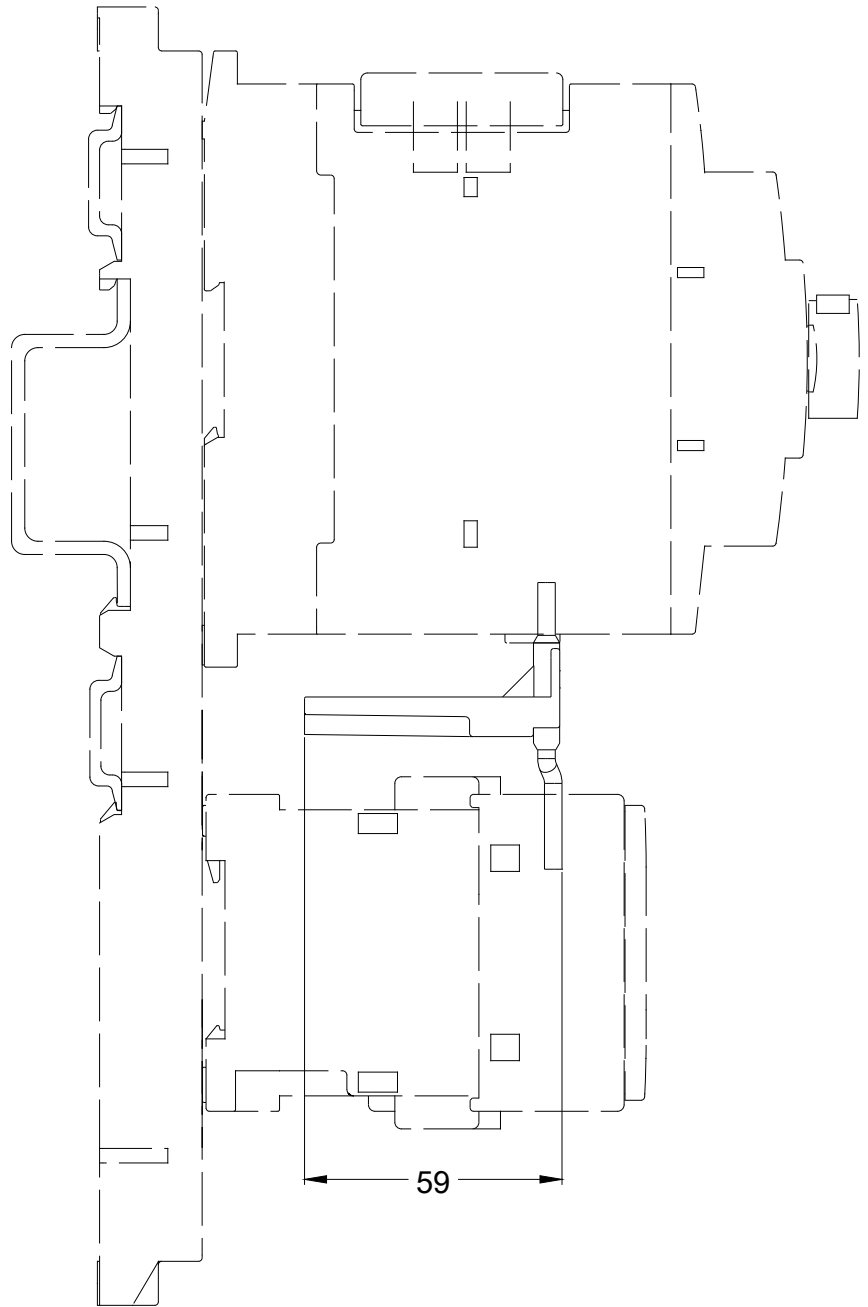
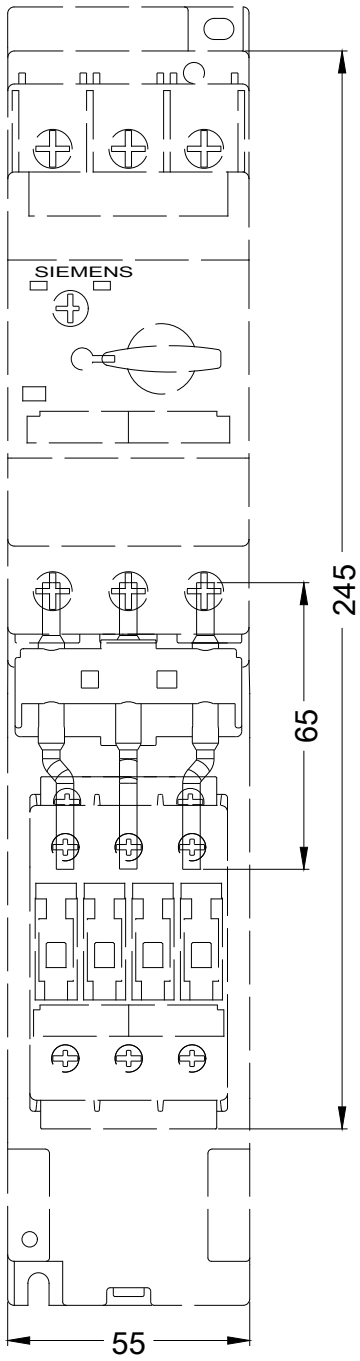

letzte Änderung:

13.04.2017