

3-Phasen-Einspeiseklemme für 3-Phasen-Sammelschiene Anschluss von oben Baugröße S00/S0

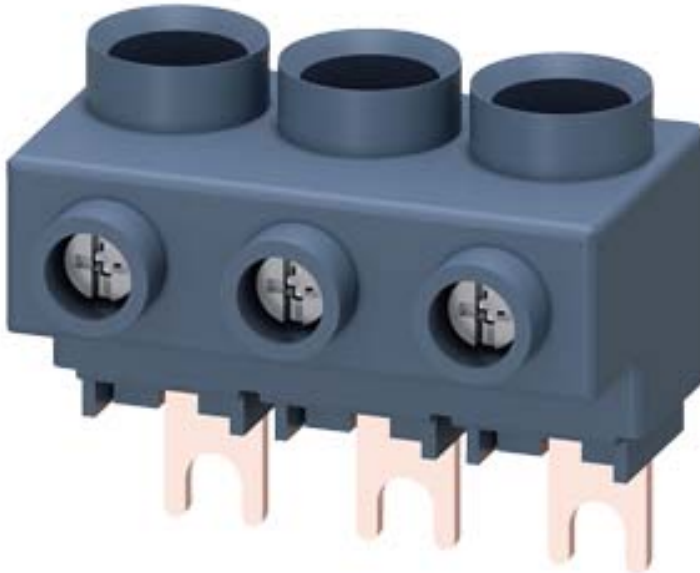

Allgemeine technische Daten:

Produkt-Markename		SIRIUS
Produkt-Bezeichnung		3-Phasen Einspeiseklemme
Ausführung des Produkts		von oben, Baugröße S0/S00
Baugröße des Leistungsschalters		S00, S0
Schutzart IP frontseitig		IP20
Isolationsspannung bei Verschmutzungsgrad 3 Bemessungswert	V	690
Umgebungstemperatur		
• während Lagerung	°C	-50 ... +80
• während Betrieb	°C	-20 ... +60
Strombelastbarkeit maximal	A	63

Einbau/ Befestigung/ Abmessungen:

Breite	mm	44,5
Höhe	mm	39
Tiefe	mm	27,2





Anschlüsse/ Klemmen:

Ausführung des elektrischen Anschlusses für Hauptstromkreis		Schraubanschluss
Art der anschließbaren Leiterquerschnitte		
<ul style="list-style-type: none"> • für Hauptkontakte <ul style="list-style-type: none"> — eindrätig — mehrdrätig — feindrätig <ul style="list-style-type: none"> — mit Aderendbearbeitung • bei AWG-Leitungen für Hauptkontakte 		1x (2,5 ... 16 mm ²) 1x (2,5 ... 25 mm ²) 1x (2,5 ... 16 mm ²) 1x (10 ... 4)

Approbationen/ Zertifikate:

Eignungsnachweis

CE / UL / CSA / CCC

allgemeine Produktzulassung	Konformitätserklärung	Prüfbescheinigungen	Schiffbau
 CSA	 UL	 EG-Konf.	 ABS
		Typprüfbescheinigung/Werkszeugnis	spezielle Prüfbescheinigung <u>n</u>

Schiffbau

 BUREAU VERITAS	 GL	 LRS	 PRS	 RINA	 RMRS
--	--	---	---	--	--

sonstiges

[Bestätigungen](#)

[Umweltbestätigung](#)



Railway

[Schwingen/Schocke](#)
n

Weitere Informationen

Information- and Downloadcenter (Kataloge, Broschüren,...)

<http://www.siemens.de/industrial-controls/catalogs>

Industry Mall (Online-Bestellsystem)

<http://www.siemens.com/industrymall>

CAX-Online-Generator

<http://support.automation.siemens.com/WW/CAXorder/default.aspx?lang=de&mlfb=3RV2925-5AB>

Service&Support (Handbücher, Betriebsanleitungen, Zertifikate, Kennlinien, FAQs,...)

<https://support.industry.siemens.com/cs/ww/de/ps/3RV2925-5AB>

Bilddatenbank (Produktfotos, 2D-Maßzeichnungen, 3D-Modelle, Geräteschaltpläne, EPLAN Makros, ...)

http://www.automation.siemens.com/bilddb/cax_de.aspx?mlfb=3RV2925-5AB&lang=de

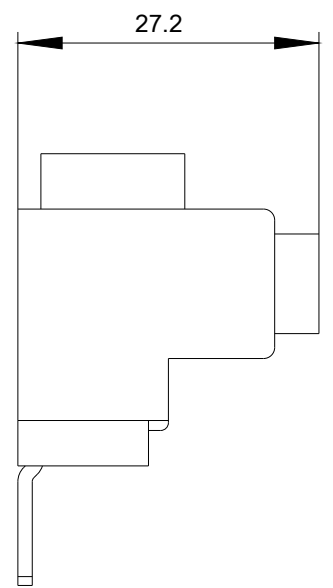
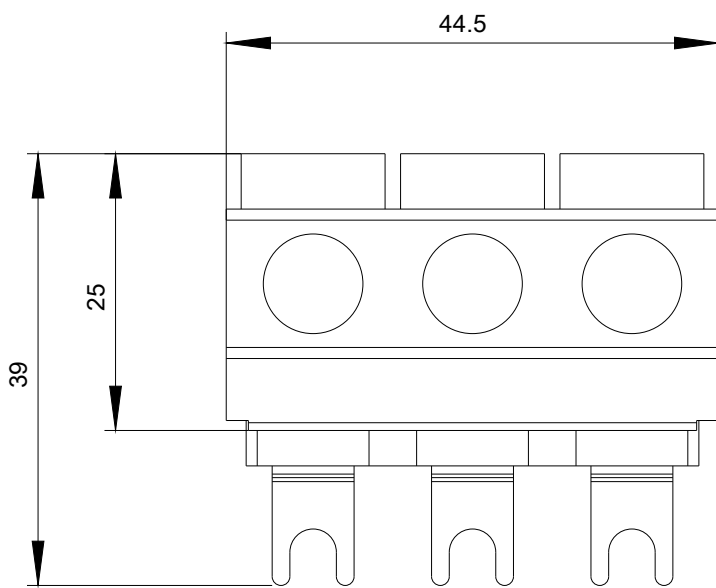

letzte Änderung:

05.04.2017