





Drahtauslöser für RESET 0,6 m für
3RU11/3RB20/3RB21 Baugröße S00...S12







Abbildung ähnlich

Allgemeine technische Daten:		
Produkt-Markename		SIRIUS
Produkt-Bezeichnung		Drahtauslöser mit Halter für RESET
Ausführung des Produkts		600 mm Länge
Baugröße des Überlastrelais		S00, S0, S2, S3
Umgebungstemperatur		
• während Lagerung	°C	-50 ... +80
• während Betrieb	°C	-20 ... +70

Approbationen/ Zertifikate:

allgemeine Produktzulassung		Konformitätserklärung	Prüfbescheinigungen		Schiffbau
			Typprüfbescheinigung/Werkszeugnis	spezielle Prüfbescheinigungen	
CSA	UL	EG-Konf.			ABS

Schiffbau				sonstiges	
				Umweltbestätigung	Bestätigungen
BUREAU VERITAS	LRS	RINA	RMRS		

Weitere Informationen

Information- and Downloadcenter (Kataloge, Broschüren,...)

<http://www.siemens.de/industrial-controls/catalogs>

Industry Mall (Online-Bestellsystem)

<http://www.siemens.com/industrymall>

CAX-Online-Generator

<http://support.automation.siemens.com/WW/CAXorder/default.aspx?lang=de&mlfb=3RU1900-1C>

Service&Support (Handbücher, Betriebsanleitungen, Zertifikate, Kennlinien, FAQs,...)

<https://support.industry.siemens.com/cs/ww/de/ps/3RU1900-1C>

Bilddatenbank (Produktfotos, 2D-Maßzeichnungen, 3D-Modelle, Geräteschaltpläne, EPLAN Makros, ...)

http://www.automation.siemens.com/bilddb/cax_de.aspx?mlfb=3RU1900-1C&lang=de

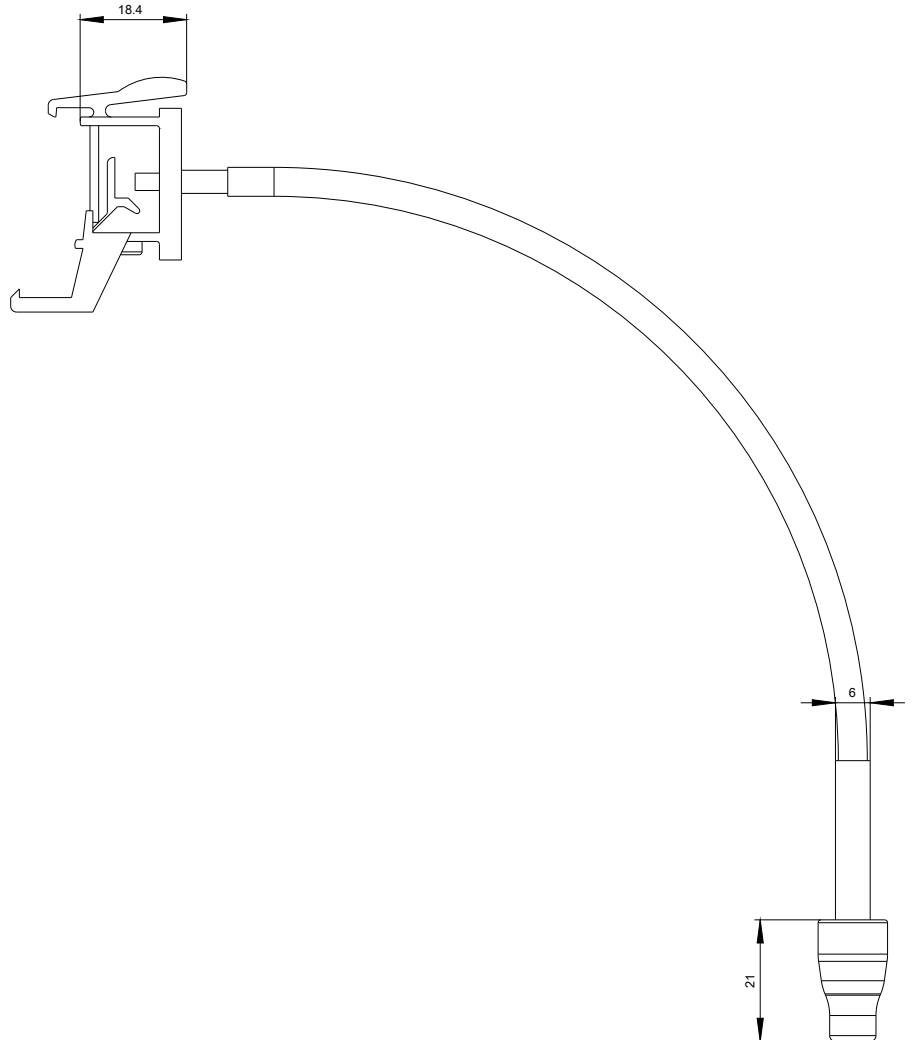
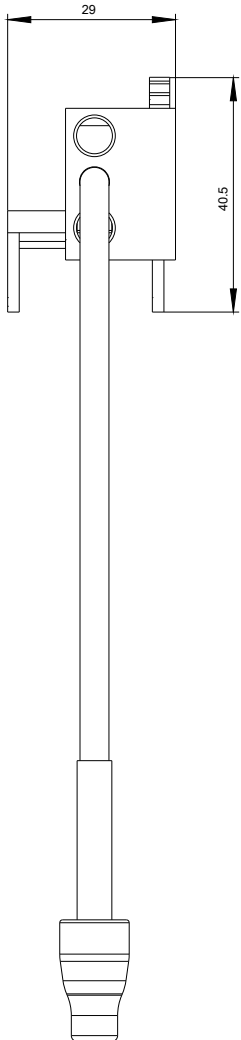

letzte Änderung:

13.04.2017