

Drahtauslöser für RESET 0,4 m für  
3RU11/3RB20/3RB21 Baugröße S00...S12











Abbildung ähnlich

#### Allgemeine technische Daten:

Produkt-Markename		SIRIUS
Produkt-Bezeichnung		Drahtauslöser mit Halter für RESET
Ausführung des Produkts		400 mm Länge
Baugröße des Überlastrelais		S00, S0, S2, S3
Umgebungstemperatur		
• während Lagerung	°C	-50 ... +80
• während Betrieb	°C	-20 ... +70

#### Approbationen/ Zertifikate:

allgemeine Produktzulassung	Konformitätserklärung	Prüfbescheinigungen	Schiffbau
 CSA	 UL	 EG-Konf.	<a href="#">spezielle Prüfbescheinigungen</a> <a href="#">Typprüfbescheinigung/Werkszeugnis</a>  ABS

Schiffbau	sonstiges
 BUREAU VERITAS  LRS  RINA  RMRS	<a href="#">Umweltbestätigung</a> <a href="#">Bestätigungen</a>

## Weitere Informationen

**Information- and Downloadcenter (Kataloge, Broschüren,...)**

<http://www.siemens.de/industrial-controls/catalogs>

**Industry Mall (Online-Bestellsystem)**

<http://www.siemens.com/industrymall>

**CAX-Online-Generator**

<http://support.automation.siemens.com/WW/CAXorder/default.aspx?lang=de&mlfb=3RU1900-1B>

**Service&Support (Handbücher, Betriebsanleitungen, Zertifikate, Kennlinien, FAQs,...)**

<https://support.industry.siemens.com/cs/ww/de/ps/3RU1900-1B>

**Bilddatenbank (Produktfotos, 2D-Maßzeichnungen, 3D-Modelle, Geräteschaltpläne, EPLAN Makros, ...)**

[http://www.automation.siemens.com/bilddb/cax\\_de.aspx?mlfb=3RU1900-1B&lang=de](http://www.automation.siemens.com/bilddb/cax_de.aspx?mlfb=3RU1900-1B&lang=de)

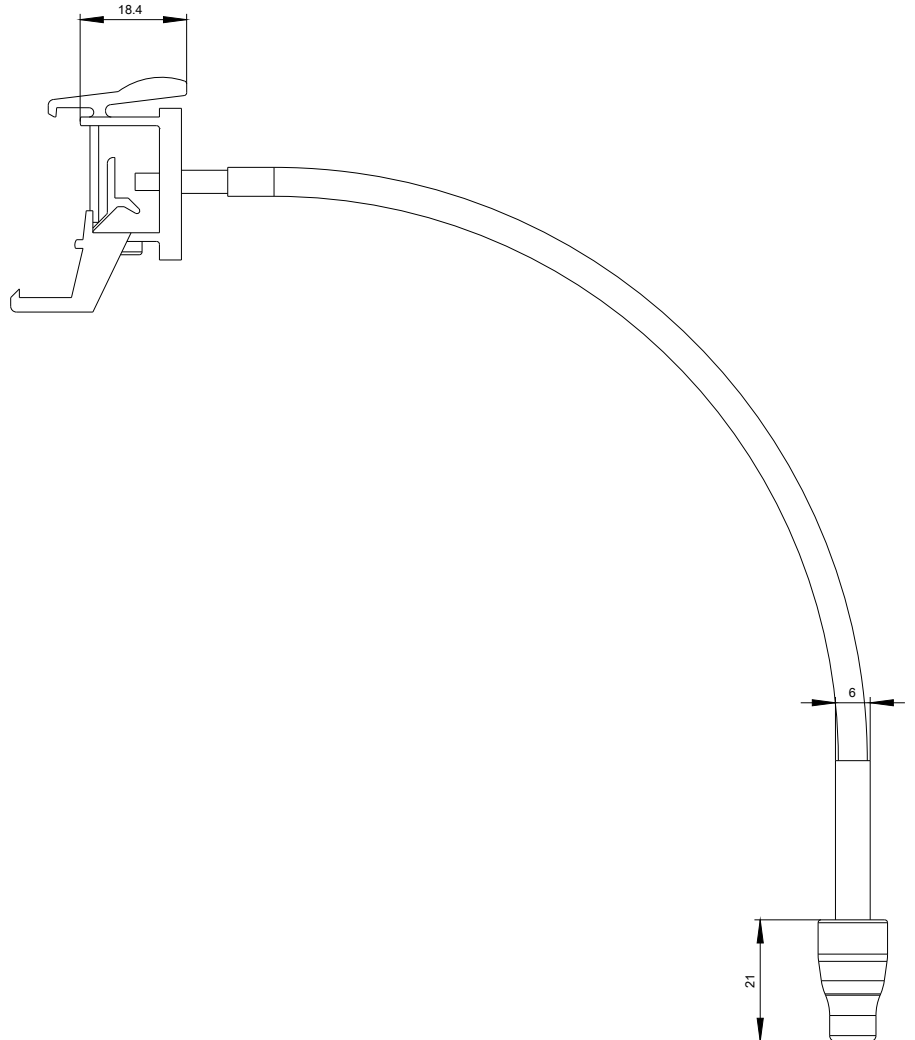
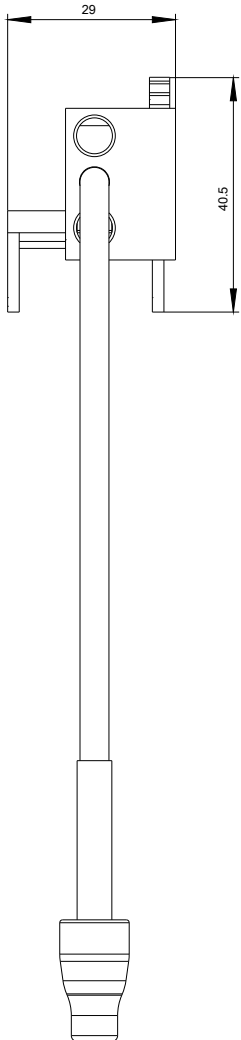

letzte Änderung:

01.05.2017