









Drahtauslöser für RESET 0,6 m für 3RU2 Baugröße S00...S2



Abbildung ähnlich

Allgemeine technische Daten:		
Produkt-Markename		SIRIUS
Produkt-Bezeichnung		Drahtauslöser mit Halter für RESET
Ausführung des Produkts		600 mm Länge
Baugröße des Überlastrelais		S00, S0
Umgebungstemperatur		
• während Lagerung	°C	-50 ... +80
• während Betrieb	°C	-20 ... +70
Einbau/ Befestigung/ Abmessungen:		
Länge	mm	600
Einbaudurchmesser	mm	6,5
Approbationen/ Zertifikate:		

allgemeine Produktzulassung		Konformitätserklärung	Prüfbescheinigungen	Schiffbau	
 CSA	 UL	 EG-Konf.	Typprüfbescheinigung/Werkszeugnis	 ABS	 BUREAU VERITAS
Schiffbau			sonstiges		
 PRS	 RINA	 RMRS	Umweltbestätigung	Bestätigungen	

Weitere Informationen

Information- and Downloadcenter (Kataloge, Broschüren,...)

<http://www.siemens.de/industrial-controls/catalogs>

Industry Mall (Online-Bestellsystem)

<http://www.siemens.com/industrymall>

CAX-Online-Generator

<http://support.automation.siemens.com/WW/CAXorder/default.aspx?lang=de&mlfb=3RU2900-1C>

Service&Support (Handbücher, Betriebsanleitungen, Zertifikate, Kennlinien, FAQs,...)

<https://support.industry.siemens.com/cs/ww/de/ps/3RU2900-1C>

Bilddatenbank (Produktfotos, 2D-Maßzeichnungen, 3D-Modelle, Geräteschaltpläne, EPLAN Makros, ...)

http://www.automation.siemens.com/bilddb/cax_de.aspx?mlfb=3RU2900-1C&lang=de

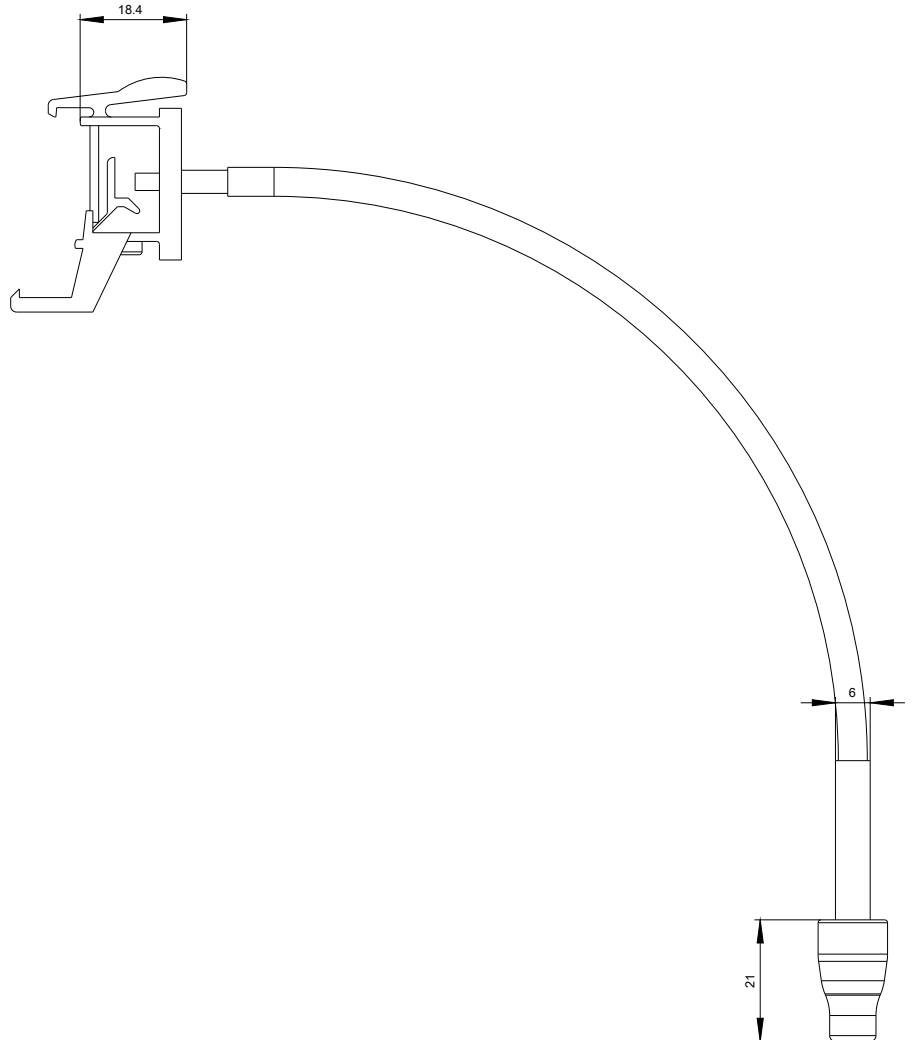
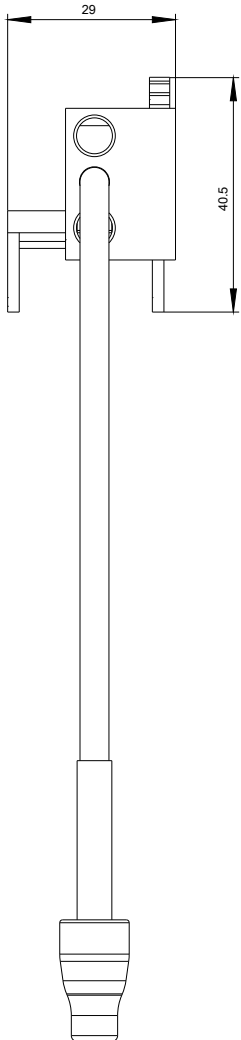

letzte Änderung:

13.04.2017