











Abbildung ähnlich

Allgemeine technische Daten:		
Produkt-Markename		SIRIUS
Produkt-Bezeichnung		Mechanisches RESET
Ausführung des Produkts		Entriegelungsschieber, Halter und Trichter
Baugröße des Überlastrelais		S00, S0
Umgebungstemperatur		
• während Lagerung	°C	-50 ... +80
• während Betrieb	°C	-20 ... +70

Approbationen/ Zertifikate:

allgemeine Produktzulassung		Konformitätserklärung	Prüfbescheinigungen	Schiffbau	
 CSA	 UL	 EG-Konf.	<a href="#">Typprüfbescheinigung/Werkszeugnis</a>	 ABS	 BUREAU VERITAS
Schiffbau			sonstiges		
 PRS	 RINA	 RMRS	<a href="#">Umweltbestätigung</a>	<a href="#">Bestätigungen</a>	

### Weitere Informationen

**Information- and Downloadcenter (Kataloge, Broschüren,...)**

<http://www.siemens.de/industrial-controls/catalogs>

**Industry Mall (Online-Bestellsystem)**

<http://www.siemens.com/industrymall>

**CAX-Online-Generator**

<http://support.automation.siemens.com/WW/CAXorder/default.aspx?lang=de&mlfb=3RU2900-1A>

**Service&Support (Handbücher, Betriebsanleitungen, Zertifikate, Kennlinien, FAQs,...)**

<https://support.industry.siemens.com/cs/ww/de/ps/3RU2900-1A>

**Bilddatenbank (Produktfotos, 2D-Maßzeichnungen, 3D-Modelle, Geräteschaltpläne, EPLAN Makros, ...)**

[http://www.automation.siemens.com/bilddb/cax\\_de.aspx?mlfb=3RU2900-1A&lang=de](http://www.automation.siemens.com/bilddb/cax_de.aspx?mlfb=3RU2900-1A&lang=de)

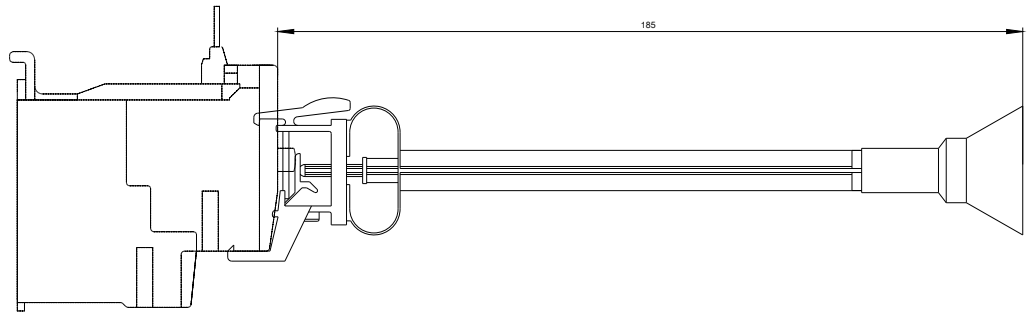
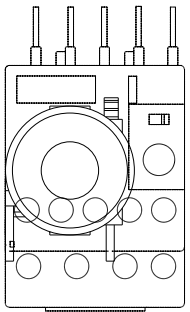

letzte Änderung:

13.04.2017