

RKMW/LED

Aktor-/Sensor-Anschlussleitung, M8-Winkelkupplung mit LED-Betriebs- und Funktionsanzeige, Rastverschluss und angespritztem Kabel

Actuator/sensor cordset, single-ended, M8 female right angle connector with LED operation and function indicator, snap-in joint and molded cable

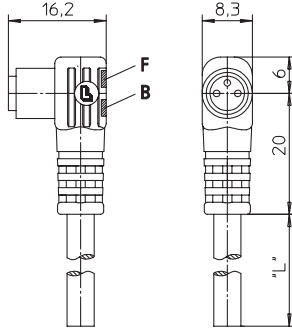

- B Betriebsanzeige grün
operation indicator green
- F Funktionsanzeige gelb
function indicator yellow

RKMWW/LED

Aktor-/Sensor-Anschlussleitung, M8-Winkelkupplung mit LED-Betriebs- und Funktionsanzeige, selbstsicherndem Schraubverschluss und angespritztem Kabel

Actuator/sensor cordset, single-ended, M8 female right angle connector with LED operation and function indicator, self-locking threaded joint and molded cable

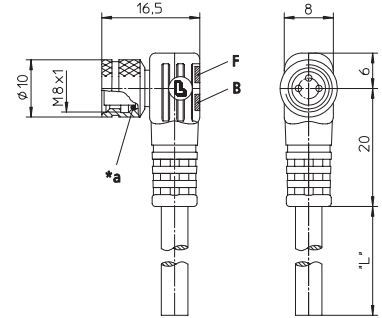

- *a O-Ring
O-ring
- B Betriebsanzeige grün
operation indicator green
- F Funktionsanzeige gelb
function indicator yellow

Pinbelegung Pin assignment

3-polig
3 poles



- 1 = braun / brown
- 3 = blau / blue
- 4 = schwarz / black

Schaltbild Wiring diagram



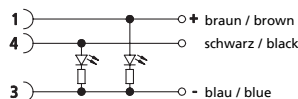







A pnp-Schließer /
pnp Normally open =
gelb-grün / yellow-green



Sonderbeschaltungen auf Anfrage / Special circuits on request

Anschlussleitungen für Aktoren, Sensoren und Verteiler Cordsets, single-ended, for actuators, sensors and distribution boxes

Technische Daten		Technical data	
Umgebungstemperatur	-25°C / +80°C	Operating temperature range	-25°C / +80°C
Werkstoffe		Materials	
Gehäuse / Griffkörper	TPU, selbstverlöschend	Housing / Molded body	TPU, self-extinguishing
Kontaktträger	TPU, selbstverlöschend	Insert	TPU, self-extinguishing
Kontakt	CuZn, unternickelt und 0,8 µm vergoldet	Contact	CuZn, pre-nickeled and 0.8 microns gold-plated
Gewindebuchse / Rändelschraube/-mutter / Sechskantschraube/-mutter / Hülse	CuZn, vernickelt (nur RKMWW/LED)	Receptacle shell / knurled screw/nut / hexagon screw/nut / sleeve	CuZn, nickel-plated (only RKMWW/LED)
O-Ring	FKM (nur RKMWW/LED)	O-ring	FKM (only RKMWW/LED)
Mechanische Daten		Mechanical data	
Schutzart	RKMW/LED: IP 65 RKMWW/LED: IP 67/IP69K Nur im gesteckten bzw. verschraubten Zustand mit den dazugehörigen Gegenstücken.	Degree of protection	RKMW/LED: IP 65 RKMWW/LED: IP 67/IP69K Only in locked position with its proper counterparts.
Elektrische Daten		Electrical data	
Durchgangswiderstand	≤ 5 mΩ	Contact resistance	≤ 5 mΩ
Nennstrom bei 40°C	4 A	Nominal current at 40°C	4 A
Nennspannung	10–30 V DC	Nominal voltage	10–30 V DC
Bemessungsspannung	32 V	Rated voltage	32 V
Isolationswiderstand	> 10 ⁹ Ω	Insulation resistance	> 10 ⁹ Ω
Verschmutzungsgrad	3	Pollution degree	3

Bestellbezeichnung Designation	Polzahl Poles	Mantel Outer jacket	
RKMW/LED A 3-06/... M		PVC	
RKMWW/LED A 3-06/... M		PVC	 
RKMW/LED A 3-224/... M	3	PUR halogenfrei / halogen free	  
RKMWW/LED A 3-224/... M		PUR halogenfrei / halogen free	   

Standardlängen: 2 M / 5 M / 10 M
Andere Kabellängen oder Leitungsaufbauten auf Anfrage.

Standard lengths: 2 M / 5 M / 10 M
Other cable lengths or cable specifications on request.