

# Datenblatt

Bestell-Nr.: 21688

## Stecker QUICK-CONNECT TE Plus mit MULTI-GRIP Verschraubung

Ampere	<b>16A</b>
Polzahl	<b>4p (3P+PE)</b>
Uhrzeitstellung	<b>7h</b>
Spannung	<b>480 bis 500V</b>
Frequenz	<b>50 und 60Hz</b>
Schutzart	<b>IP44</b>
Kennfarbe	<b>schwarz RAL 9011</b>
Anschlußtechnik	<b>schraublose QUICK-CONNECT Anschlusstechnik</b>
Kontaktträger	<b>aus hochwärmebeständigem Material, die Kontakte sind Messing vernickelt</b>
Gehäusematerial	<b>Polyamid</b>

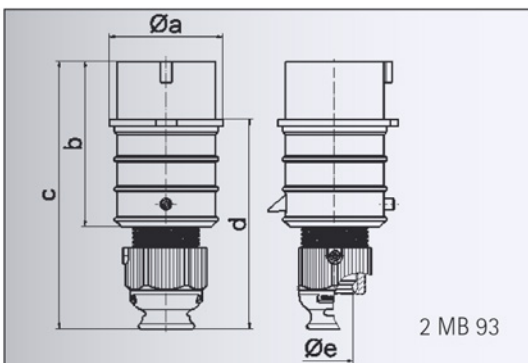

Ampere	16	16	16	32	32	32
Polzahl	3	4	5	3	4	5
a ø	51,0	57,5	65,0	66,0	66,0	72,0
b	95,0	95,0	97,0	118,0	118,0	117,0
c	145,0	145,0	152,0	178,0	178,0	181,0
d	109,0	109,0	116,0	133,0	133,0	135,5
e ø	18,0	18,0	21,0	23,0	23,0	27,0
Leiter mm <sup>2</sup> min	1	1	1	2,5	2,5	2,5
Leiter mm <sup>2</sup> max	2,5	2,5	2,5	6	6	6