

Datenblatt

Bestell-Nr.: 31976

Kupplung QUICK-CONNECT TE Plus mit MULTI-GRIP Verschraubung

Ampere	32A
Polzahl	4p (3P+PE)
Uhrzeitstellung	7h
Spannung	480 bis 500V
Frequenz	50 und 60Hz
Schutzart	IP44
Kennfarbe	schwarz RAL 9011
Anschlußtechnik	schraublose QUICK-CONNECT Anschlusstechnik
Kontaktträger	aus hochwärmebeständigem Material, die Kontakte sind Messing vernickelt
Gehäusematerial	Polyamid

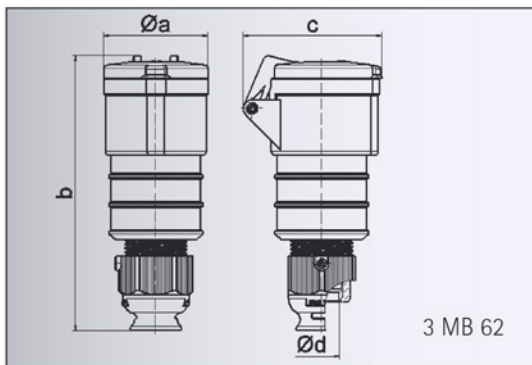

Ampere	16	16	16	32	32	32
Polzahl	3	4	5	3	4	5
a ø	51,0	58,0	65,0	66,5	66,5	72,0
b	156,0	162,0	168,0	195,0	195,0	198,0
c	72,0	78,0	86,0	89,0	89,0	99,0
d ø	18,0	18,0	21,0	23,0	23,0	27,0
Leiter mm ² min	1	1	1	2,5	2,5	2,5
Leiter mm ² max	2,5	2,5	2,5	6	6	6