

Datenblatt

Bestell-Nr.: 12768

Anbausteckdose Quick-Connect geneigt

EAN/Stück	4024941127684
Ampere	32A
Polzahl	5p (3P+N+PE)
Uhrzeitstellung	6h
Spannung	200/346 bis 240/415V
Frequenz	50 und 60Hz
Schutzart	IP44
Kennfarbe	rot RAL 3000
Anschlußtechnik	schraublose Federklemmtechnik als Käfigzugfederklemme mit Kontex-Kontakt
Kontakt	Kontaktträger aus Polyamid, die Kontakte sind aus Messing
Gewicht/Stück	0,235 kg
Verpackungseinheit	10 Stück
Gehäusematerial	Polyamid

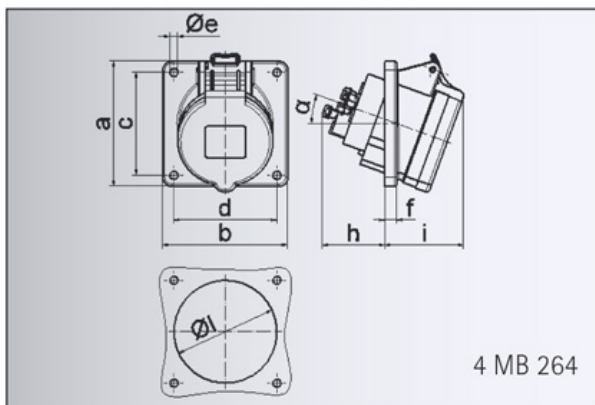

Ampere	16	16	16	32	32	32
Polzahl	3	4	5	3	4	5
a	85,0	85,0	85,0	85,0	85,0	85,0
b	85,0	85,0	85,0	85,0	85,0	85,0
c	70,0	70,0	70,0	70,0	70,0	70,0
d	70,0	70,0	70,0	70,0	70,0	70,0
e ø	5,5	5,5	5,5	5,5	5,5	5,5
f	8,0	8,0	8,0	8,0	8,0	8,0
h	46,0	46,0	46,0	61,0	61,0	61,0
i	50,0	51,0	54,0	60,0	60,0	60,0
l ø	57,0	65,0	70,0	78,0	78,0	78,0
α	20°	20°	20°	20°	20°	20°
Leiter mm ² min	1,5	1,5	1,5	2,5	2,5	2,5
Leiter mm ² max	4	4	4	10	10	10

Bals Elektrotechnik GmbH & Co. KG

D-57399 Kirchhundem - Albaum

phone: +49(0)2723/771-0 fax: +49(0)2723/771-177

email: info@bals.com www.bals.com

Datum: 16.07.2015