

Datenblatt

Bestell-Nr.: 132002

Anbausteckdose Quick-Connect gerade

EAN/Stück	4024941019248
Ampere	32A
Polzahl	5p (3P+N+PE)
Uhrzeitstellung	6h
Spannung	200/346 bis 240/415V
Frequenz	50 und 60Hz
Schutzart	IP44
Kennfarbe	rot RAL 3000
Anschlußtechnik	schraublose Federklemmtechnik als Käfigzugfederklemme mit Kontex-Kontakt
Kontakt	Kontaktträger aus Polyamid, die Kontakte sind aus Messing
Gewicht/Stück	0,219 kg
Verpackungseinheit	10 Stück
Gehäusematerial	Polyamid

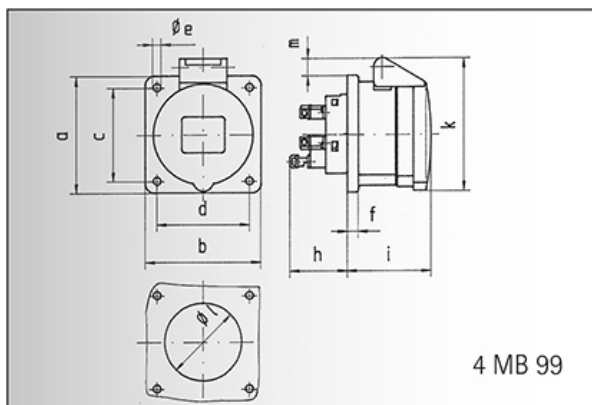

Ampere	16	16	16	32	32	32
Polzahl	3	4	5	3	4	5 5
a	75,0	75,0	75,0	75,0	75,0	75,0
b	75,0	75,0	75,0	75,0	75,0	75,0
c	60,0	60,0	60,0	60,0	60,0	60,0
d	60,0	60,0	60,0	60,0	60,0	60,0
e ø	5,5	5,5	5,5	5,5	5,5	5,5
f	7,0	7,0	7,0	8,0	8,0	8,0
h	35,5	35,5	35,5	50,0	50,0	50,0
i	50,0	50,0	51,0	60,0	60,0	60,0
k	74,0	84,0	91,0	94,0	94,0	102,0
l ø	45,0	45,0	55,0	60,0	60,0	60,0
m	3,5	7,0	11,5	12,0	12,0	17,0
Leiter mm ² min	1,5	1,5	1,5	2,5	2,5	2,5
Leiter mm ² max	4	4	4	10	10	10

Bals Elektrotechnik GmbH & Co. KG

D-57399 Kirchhundem - Albaum

phone: +49(0)2723/771-0 fax: +49(0)2723/771-177

email: info@bals.com www.bals.com

Datum: 16.07.2015