

RSC 30-RSC 50

Konfektionierbarer Steckverbinder, 7/8"-Stecker mit Schraubverschluss, Konfektionierung über Schraubklemmen

Field attachable connector, 7/8" male connector with threaded joint, assembling with screw terminals

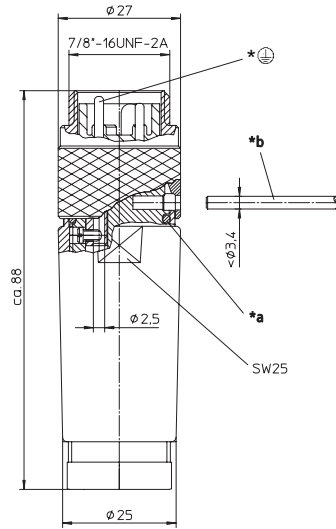

- *a O-Ring
O-ring
- *b Stift oder Schraubendreher als Montagehilfe
pin or screwdriver as assembly tool
- *⊕ Kontakt 1,5 voreilend
contact 1.5 leading

Pinbelegung Pin assignment

**3-polig
3 poles**

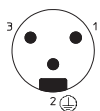

**4-polig
4 poles**

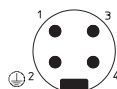



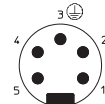







**5-polig
5 poles**



Technische Daten	
Umgebungstemperatur	-40°C / +90°C
Werkstoffe	
Gehäuse / Griffkörper	PA
Kontaktträger	TPU, selbstverlöschend
Kontakt	CuZn, versilbert und vergoldet
Gewindebuchse / Rändel- schraube/-mutter / Sechskant- schraube/-mutter / Hülse	Al eloxiert
O-Ring	NBR
Mechanische Daten	
Schutzart	IP 67 Nur im verschraubten Zustand mit den dazugehörigen Gegen- stücken.
Anschlussart	Schraubanschluss
Anschließbarer Leiter	max. 1,0 mm ²
Elektrische Daten	
Durchgangswiderstand	≤ 5 mΩ
Nennstrom bei 40°C	3-polig 12 A 4- bis 5-polig 9 A
Nennspannung	240 V
Bemessungsspannung	250 V
Prüfspannung	3-polig 2,5 kV eff. / 60 s 4- bis 5-polig 1,5 kV eff. / 60 s
Isolationswiderstand	> 10 ⁹ Ω
Verschmutzungsgrad	3

Technical data	
Operating temperature range	-40°C / +90°C
Materials	
Housing / Molded body	PA
Insert	TPU, self-extinguishing
Contact	CuZn, silver-plated and gold-plated
Receptacle shell / knurled screw/ nut / hexagon screw/nut / sleeve	Al anodized
O-ring	NBR
Mechanical data	
Degree of protection	IP 67 Only in locked position with its proper counterparts.
Mode of connection	screw terminals
Connectable conductor	max. 1.0 mm ²
Electrical data	
Contact resistance	≤ 5 mΩ
Nominal current at 40°C	3 poles 12 A 4–5 poles 9 A
Nominal voltage	240 V
Rated voltage	250 V
Test voltage	3 poles 2.5 kV eff. / 60 s 4–5 poles 1.5 kV eff. / 60 s
Insulation resistance	> 10 ⁹ Ω
Pollution degree	3

Bestellbezeichnung Designation	Polzahl Poles	Kabelverschraubung Screw joint for cable	
RSC 30/9	3	Ø 6,0–8,0 mm	 
RSC 30/11		Ø 8,0–10,0 mm	 
RSC 40/9	4	Ø 6,0–8,0 mm	 
RSC 50/9		Ø 6,0–8,0 mm	 
RSC 50/11	5	Ø 8,0–10,0 mm	 
RSC 50/16		Ø 12,0–14,0 mm	