

Datenblatt

Bestell-Nr.: 21350

Stecker QUICK-CONNECT TE Plus mit MULTI-GRIP Verschraubung

Ampere	16A
Polzahl	4p (3P+PE)
Uhrzeitstellung	7h
Spannung	480 bis 500V
Frequenz	50 und 60Hz
Schutzart	IP67
Kennfarbe	schwarz RAL 9011
Anschlußtechnik	schraublose QUICK-CONNECT Anschlusstechnik
Kontaktträger	aus hochwärmebeständigem Material, die Kontakte sind Messing vernickelt
Gehäusematerial	Polyamid

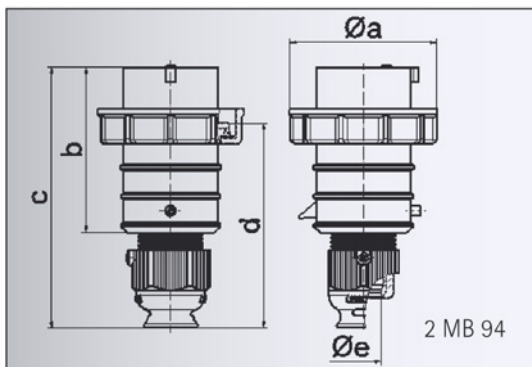

Ampere	16	16	16	32	32	32
Polzahl	3	4	5	3	4	5
a Ø	70,0	78,0	86,0	94,0	94,0	101,0
b	95,0	95,0	97,0	118,0	118,0	117,0
c	145,0	145,0	152,0	178,0	178,0	181,0
d	111,0	111,0	119,0	136,0	136,0	138,5
e Ø	18,0	18,0	21,0	23,0	23,0	27,0
Leiter mm ² min	1	1	1	2,5	2,5	2,5
Leiter mm ² max	2,5	2,5	2,5	6	6	6
